

MCR100- 6,- 8 Silicon Controlled Rectifier

FEATURES

- Current- I_{GT} : 200 μ A
- I_{TRMS} : 0.8 A
- V_{RRM}/V_{DRM} : MCR100-6: 400 V
MCR100-8: 600 V
- Operating and storage junction temperature range
 T_J, T_{stg} : -55°C to +150°C

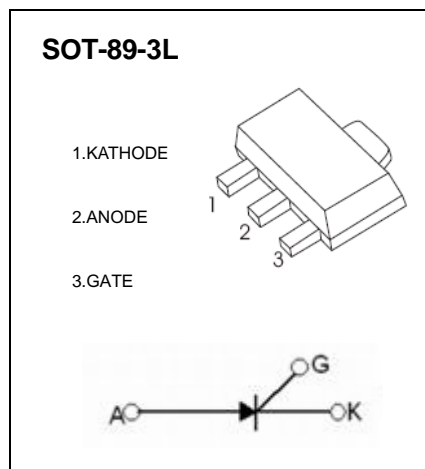

ELECTRICAL CHARACTERISTICS (Ta=25°C unless otherwise specified)

Parameter	Symbol	Test conditions	Min	Max	Unit	
On state voltage	V_{TM}^*	$I_{TM}=1A$		1.7	V	
Gate trigger voltage	V_{GT}	$V_{AK}=7V$		0.8	V	
Peak Repetitive forward and reverse blocking voltage MCR100-6 MCR100-8	V_{DRM} AND V_{RRM}	$I_{DRM}=10\mu A$	400 600		V	
Peak forward or reverse blocking Current	I_{DRM} I_{RRM}	$V_{AK} = \text{Rated}$ V_{DRM} or V_{RRM}		10	μ A	
Holding current	I_H	$I_{HL}=20mA, V_{AK}=7V$		5	mA	
Gate trigger current	I_{GT}	$V_{AK}=7V$	A2	5	15	μ A
			A1	15	30	μ A
			A	30	80	μ A
			B	80	200	μ A

* Forward current applied for 1 ms maximum duration, duty cycle $\leq 1\%$.

Typical Characteristics

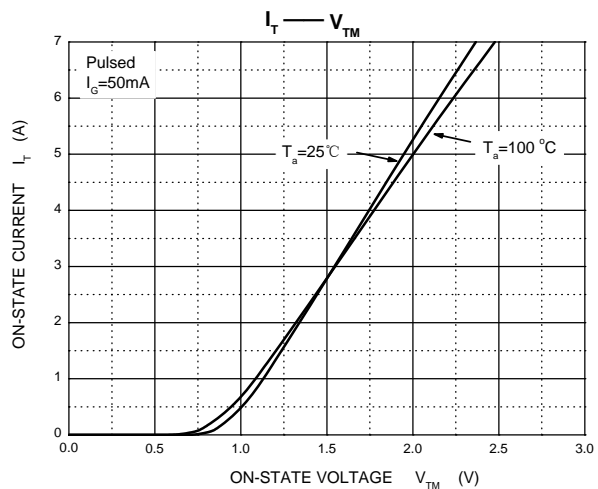
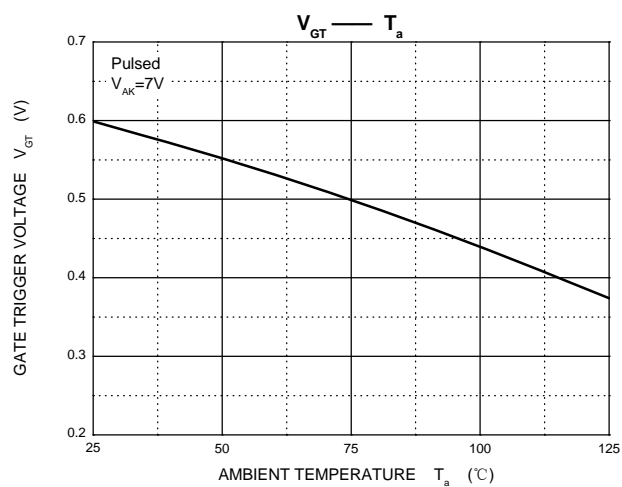
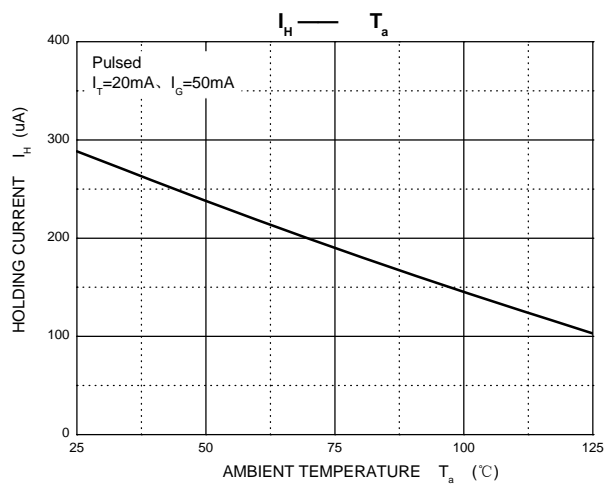
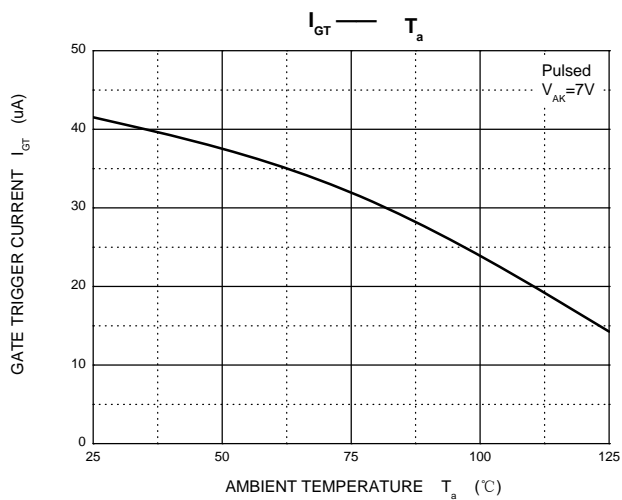

SOT-89-3L Package Outline Dimensions

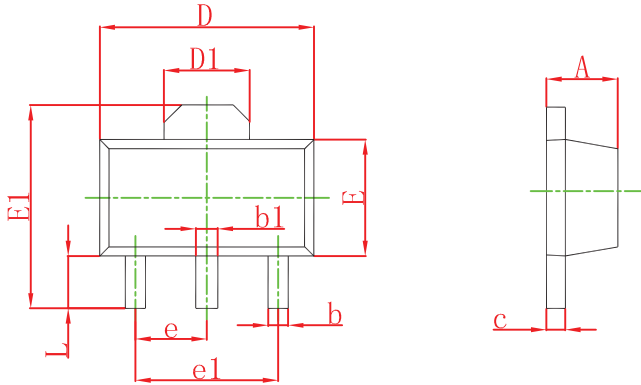

Symbol	Dimensions In Millimeters		Dimensions In Inches	
	Min	Max	Min	Max
A	1.400	1.600	0.055	0.063
b	0.320	0.520	0.013	0.020
b1	0.400	0.580	0.016	0.023
c	0.350	0.440	0.014	0.017
D	4.400	4.600	0.173	0.181
D1	1.550 REF.		0.061 REF.	
E	2.300	2.600	0.091	0.102
E1	3.940	4.250	0.155	0.167
e	1.500 TYP.		0.060 TYP.	
e1	3.000 TYP.		0.118 TYP.	
L	0.900	1.200	0.035	0.047

SOT-89-3L Suggested Pad Layout

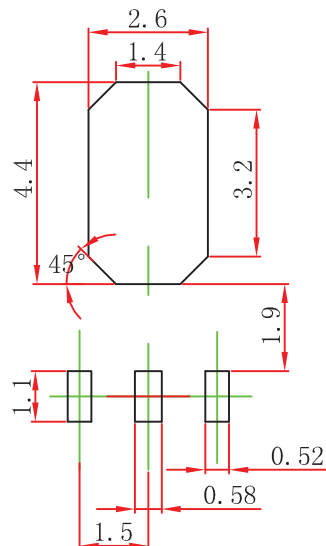

Note:

1. Controlling dimension: in millimeters.
2. General tolerance: $\pm 0.05\text{mm}$.
3. The pad layout is for reference purposes only.

SOT-89-3L Tape and Reel

SOT-89-3L Embossed Carrier Tape

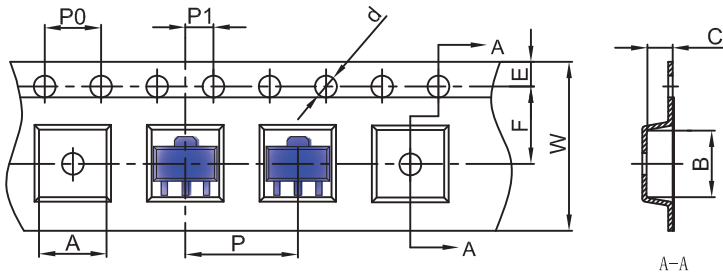

Packaging Description:
 SOT-89-3L parts are shipped in tape. The carrier tape is made from a dissipative (carbon filled) polycarbonate resin. The cover tape is a multilayer film (Heat Activated Adhesive in nature) primarily composed of polyester film, adhesive layer, sealant, and anti-static sprayed agent. These reeled parts in standard option are shipped with 1,000 units per 7" or 18.0 cm diameter reel. The reels are clear in color and is made of polystyrene plastic (anti-static coated).

Dimensions are in millimeter										
Pkg type	A	B	C	d	E	F	P0	P	P1	W
SOT-89-3L	4.85	4.45	1.85	Ø1.50	1.75	5.50	4.00	8.00	2.00	12.00
(Tolerance)	+/-0.1	+/-0.1	+/-0.1	+/-0.1	+/-0.1	+/-0.1	+/-0.1	+/-0.1	+/-0.1	+0.3/-0.1

SOT-89-3L Tape Leader and Trailer

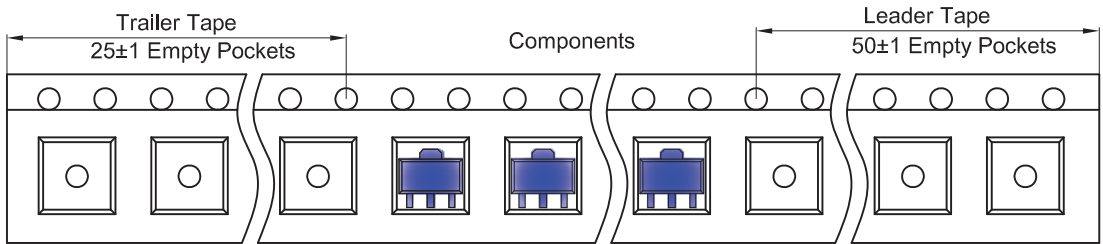

SOT-89-3L Reel

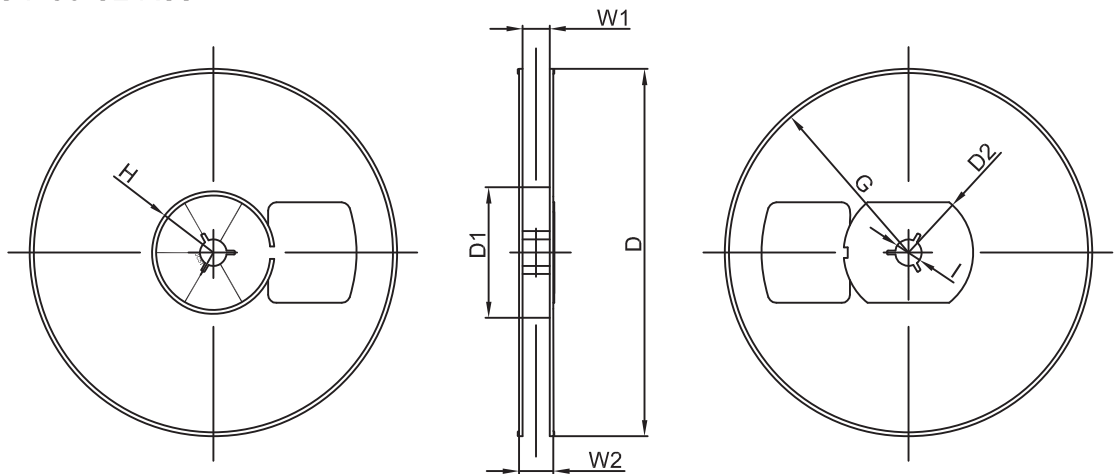

Dimensions are in millimeter								
Reel Option	D	D1	D2	G	H	I	W1	W2
7" Dia	Ø180.00	60.00	R32.00	R86.50	R30.00	Ø13.00	13.20	16.50
Tolerance	+/-2	+/-1	+/-1	+/-1	+/-1	+/-1	+/-1	+/-1

REEL	Reel Size	Box	Box Size(mm)	Carton	Carton Size(mm)	G.W.(kg)
1000 pcs	7 inch	10,000 pcs	203×203×195	40,000 pcs	438×438×220	